

**Haystack Small Radio Telescope**  
**Hardware Installation Manual**  
Compiled by Dustin Johnson, June-August 2012



**MIT**  
**HAYSTACK**  
**OBSERVATORY**

## Table of Contents

Assembly Note	2
Acquiring Parts	2
Dish Selection	2
Mounting the Dish	3
Assembly of the Feed and LNA	5
Assembly of the LNA	5
Assembly of the Feed	8
Mounting the Feed	14
Assembly of the Receiver	15
Receiver Mounting Plate	16
Receiver Box	16
Assembly of the 90° Converter and High Pass Filter	16
Final Assembly	22
PC Interface	30
Rotor Controller	30
Rotor Alignment	31
A Note on Calibration	32

This manual contains all the necessary information to build and set up the required hardware for the SRT. There are five main components: the telescope (dish and mount), the feed and low-noise amplifier, the receiver, the antenna mount controller, and the PCI card. All of these components are necessary for a new SRT, but only the receiver and feed/LNA need to be built for an SRT upgraded from the original.

### **Assembly Note**

When assembling the components of the SRT, keep in mind that the pictures provided are of the prototype built at Haystack, and some changes were incorporated into the plans based on lessons learned during assembly. As well, some parts were obtained from local stocks rather than the suppliers noted in the parts list, so appearance of some parts may be different.

### **Acquiring Parts**

The components necessary for the SRT were selected to make assembly as easy as possible, with minimal machining, milling, and soldering. Components were also selected to come from as few different suppliers as possible: most come from Digi-Key, Mini-Circuits, Mouser, and McMaster-Carr. Most of the small hardware (i.e. screws, nuts, washers) are only available in bulk online, so it may be desirable to purchase these parts individually from a local hardware store.

### **Dish Selection**

There are a variety of possibilities for the dish used for the SRT, depending on what it is used for and the budget available. The most versatile but most expensive choice is a motorized, computer-controlled mount with a 2.3m dish. The supported mount is the SPID RAS azimuth-elevation rotor and controller from SPID Elektronik<sup>1</sup> of Poland, which the provided application is designed to interface with. The SPID costs \$1,900 to \$3,000, depending on the weight requirement.

Due to the decline of C band satellite TV, large C band dishes are no longer as commonly available. A dish similar to that used on the prototype SRT is still available from Orbit Communications<sup>2</sup>. Sadoun<sup>3</sup> carries an inexpensive 1.8m dish, though its quality is not as high. A few other companies provide new dishes, such as Satcom Resources<sup>4</sup> and Global Communications<sup>5</sup>, though they are more expensive. Other dishes can often be found second-hand through the internet. For weight reasons, mesh dishes are the best, but are presently not manufactured in North America. RF Ham Design<sup>6</sup> of the Netherlands carries a variety of mesh dishes. The parts list includes the Orbit Communications, Sadoun and RF Ham Design dishes.

If computer controlled steering is not desired or too expensive, several other options are available: a conventional polar satellite dish mount, with or without motorized actuators for pointing; a hand or electrically controlled azimuth-elevation mount; or a fixed mount. Most new dishes are available with a polar mount and some with a non-motorized azimuth-elevation mount. Use of any mount but the SPID will require some modifications to the software.

---

<sup>1</sup> [www.spid.alpha.pl/english/11.php](http://www.spid.alpha.pl/english/11.php)

<sup>2</sup> [www.orbitcommunications.com/cyberstore/product.asp?PID=S-7.5](http://www.orbitcommunications.com/cyberstore/product.asp?PID=S-7.5)

<sup>3</sup> [www.sadoun.com](http://www.sadoun.com)

<sup>4</sup> [www.satcomresources.com](http://www.satcomresources.com)

<sup>5</sup> [www.global-cm.net](http://www.global-cm.net)

<sup>6</sup> [www.rfhamdesign.com/index.html](http://www.rfhamdesign.com/index.html)

## Mounting the Dish

The dish can either be mounted on the roof of a building or somewhere outside. It is best to have as few obstructions to the sky as possible, though having a nearby tree act as an absorber for calibration may be useful. It is also desirable to have the telescope as far away from a building as possible to reduce interference from computers and other electronics.

Two different mounting methods are recommended: a concrete pier or a non-penetrating roof mount. The concrete pier is permanent and requires a sufficient depth of soil to pour the mount. The non-penetrating mount can either be used on a flat roof or on flat ground, and can be disassembled and moved with relative ease.

### *Concrete Pier*

This section is adapted from the original SRT manual.

Remember that this is a permanent installation and moving the telescope requires a new pier to be built. Also note that soil mechanics can vary widely depending on the geographical location of the installation site. For this reason, it is recommended that you consult local building codes for information on how to properly install the pillar mount.

- The pier foundation requires a round hole 30 inches in diameter and 4 feet deep. For areas that experience severe weather, be sure to dig the hole below the frost line.
- Angle the sides of the hole outward so that it tapers towards the bottom. This will prevent the pillar from shifting during severe weather.
- To improve drainage, fill the bottom of the hole with several inches of loose gravel.
- The Spid rotor is designed to fit onto a 2.375" OD pipe. For the pier, use a section of 2" schedule 40 pipe 8 feet long (this has an outer diameter of 2.375").
- Place the pipe in the center of the hole and fill the hole with concrete (roughly 2/3 cubic yard), keeping the pipe level. This large a quantity of concrete should be prepared in a mixer or purchased from a concrete company.
- Once the concrete is in, carefully level the pipe by placing a level against it, parallel to the pipe's axis, and moving the pipe until the level reads vertical. Check this multiple times at two points 90° apart.
- Once the pipe is level, use several boards to keep it from shifting while the concrete cures.

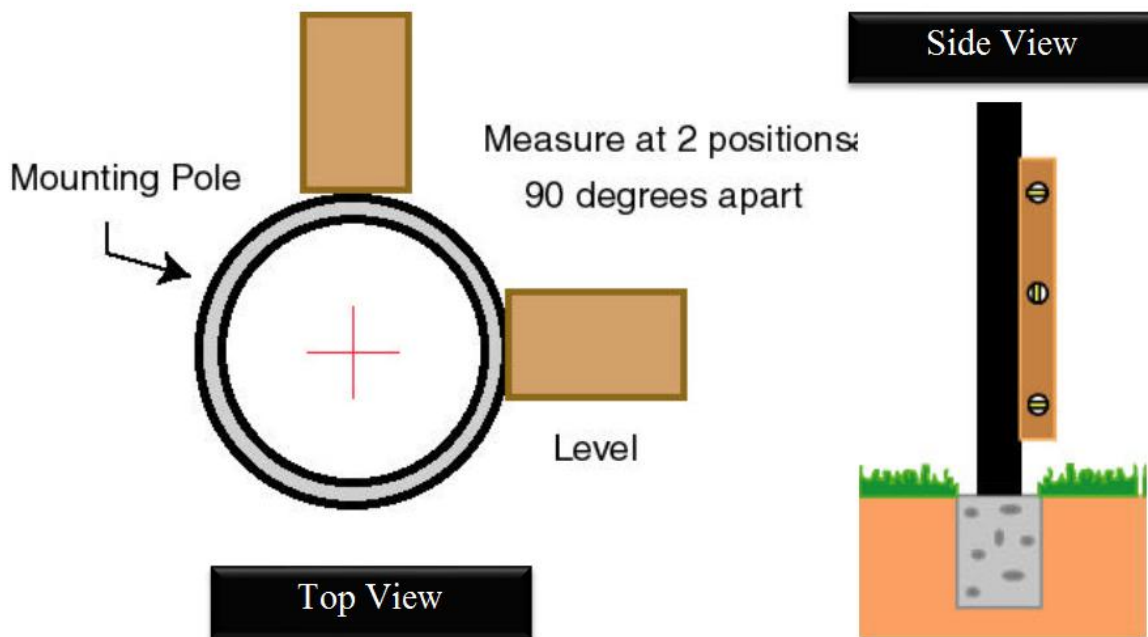


Figure 1: Leveling of the mounting pipe.

#### *Non-Penetrating Roof Mount*

These mounts are ideal for use on the flat roof of a building or on level ground, and can be relocated with little effort. However, mounts large enough for a 2.3m dish are not common commercially. The prototype SRT uses a Kaul-Tronics NPRM-10 mount. However, Kaul-Tronics appears to be defunct. As of this writing, this mount was still available from Skyvision<sup>7</sup>. Another roof mount is available from Orbit Communications<sup>8</sup>.

The mount has a wide base supporting a 3" OD pipe. The SPID rotor is designed for a 2.875" OD pipe. Alfa Radio, the SPID's North American distributor, carries an adapter to fit on a 4" pipe. The base is held down by ballast such as concrete blocks. If the mount is being placed on a roof, be sure to check with the appropriate authorities that the roof can support the load.

<sup>7</sup> [www.skyvision.com/store/mi6012006.html](http://www.skyvision.com/store/mi6012006.html)

<sup>8</sup> [www.orbitcommunications.com/cyberstore/cband/mounts.htm](http://www.orbitcommunications.com/cyberstore/cband/mounts.htm)



**Figure 2: The Kaul-Tronics NPRM-10 mount for the prototype SRT. Concrete blocks or other counterweights should be placed in the six sections around the perimeter.**

Once the mount is complete, the rotor or other chosen dish mount can be attached to it. Depending on which dish you are using, some form of bracket will have to be manufactured to attach the dish to the elevation axis of the SPID. As a specific dish is not currently supported by the SRT, you should consult with a technician or engineer on the design of the bracket and other custom hardware necessary for your installation.

### **Assembly of the Feed and LNA**

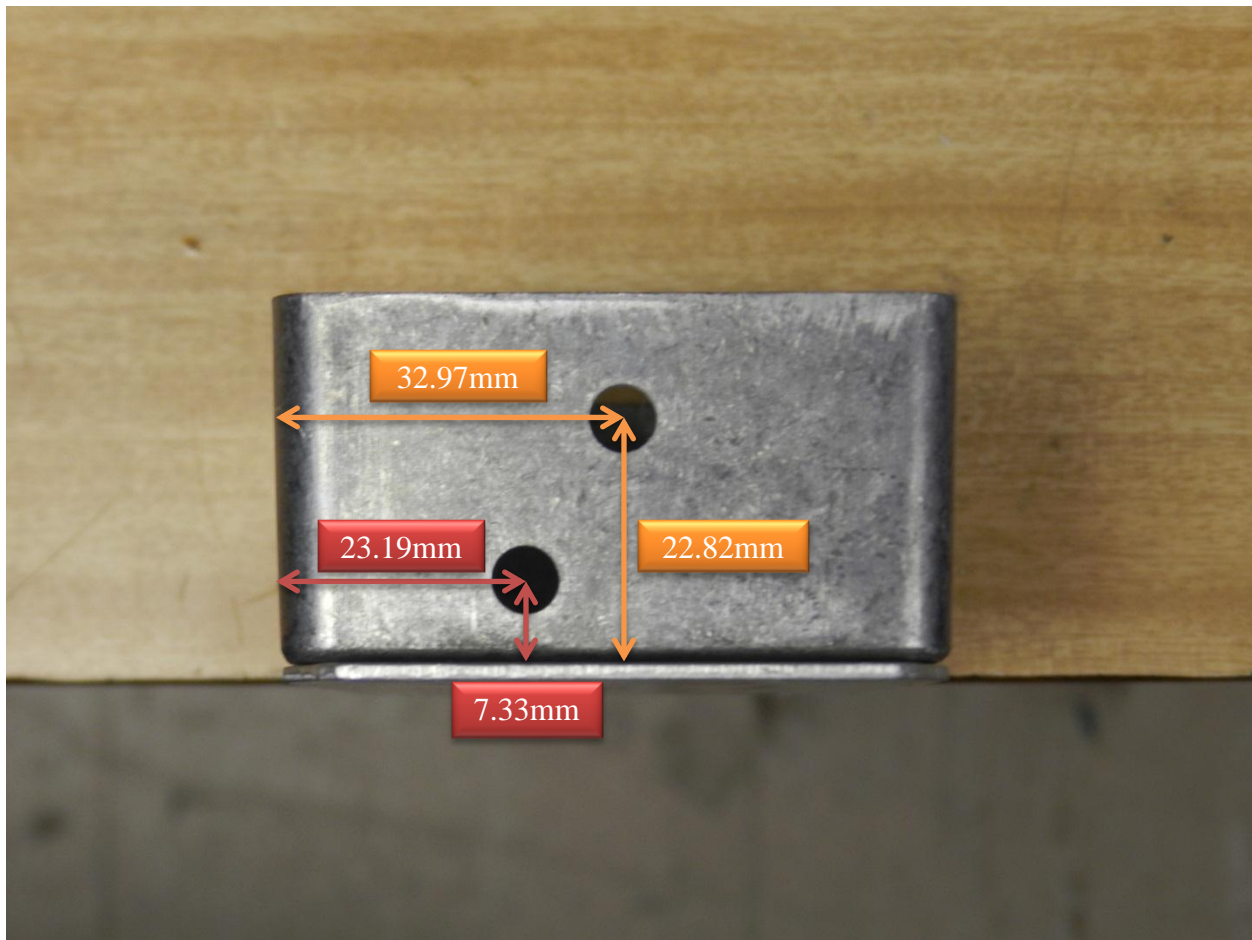
The feed consists of a low-profile helical antenna backed by an aluminum cavity. The helix is composed of copper tape wrapped around a polystyrene foam core, with a foil plate to match its impedance to that of the cable, which is peripherally fed. The cavity is a simple round cake pan.

The low-noise amplifier (LNA) is located in a watertight box mounted on the back of the cavity, and causes minimal additional blockage of the aperture. The LNA itself consists of two ultra-low-noise amplifier modules, a band-pass filter, and a bias-tee to power the amplifiers.

### *Assembly of the LNA*

Only two holes are required in the LNA case, and their positions are shown in the image below. For this portion of the assembly you will need following components from the Feed and LNA portion of the parts list, as well as solder and tools:

- 2 Mini-Circuits SF-SF50+ SMA-F to SMA-F adapters
- 1 Mini-Circuits 086-4SM+ 4" SMA cable
- 1 Mini-Circuits 086-6SM+ 6" SMA cable
- 2 7/32" inner diameter O-rings
- Hammond Manufacturing 1590WN1F waterproof aluminum enclosure
- 2 Mini-Circuits ZX60-1614LN-S amplifiers
- 1 Mini-Circuits VBF-1445+ bandpass filter
- 1 Mini-Circuits ZFBT-4R2G-FT+ bias-tee
- 22 gauge stranded wire, orange

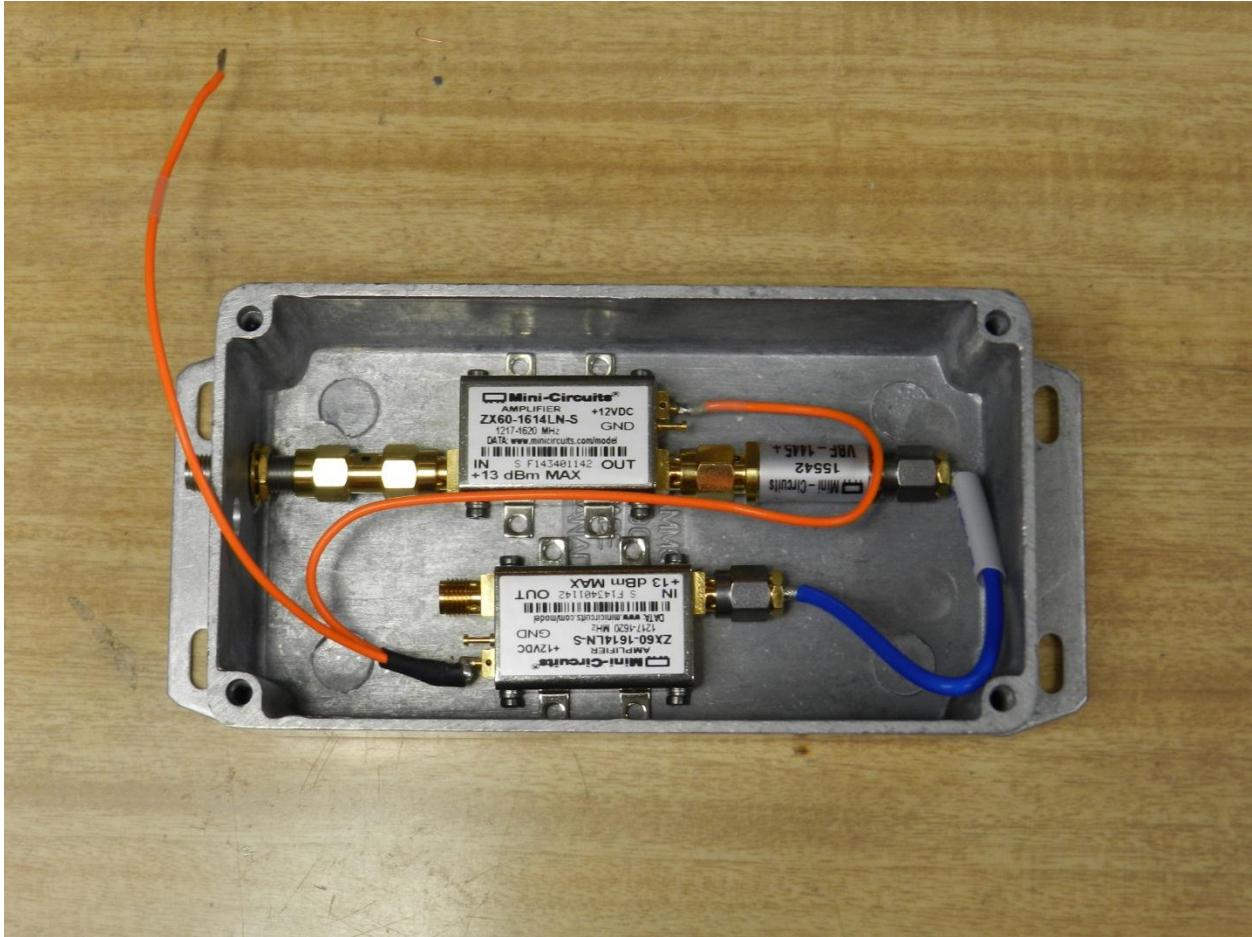


**Figure 3: Position of the two holes in the LNA case. Note that vertical dimensions are from the top of the mounting plate and horizontal dimensions are from the edge at the same level as the hole. Both holes are 1/4".**

- Drill the two holes 1/4" holes in the case. A drill press with a vice will probably work best.
- Remove the nut and lock washer from one of the SMA-F to SMA-F bulkhead connectors. Slide an O-ring up the longer threaded portion until it is against the back of the flange. Insert the longer side through the lower hole in the case and secure it there with the lock washer and nut, tightening with a wrench.
- Connect the filter to the out port of the ZX60-1614LN-S amplifier, and the SMA-M to SMA-M adapter to the "In" port. Attach the 3" SMA cable to the other end of the filter.

Place this assembly in the box and connect the SMA-M to SMA-M adapter to the end of the SMA bulkhead connector.

- Attach the other end of the SMA cable to the “In” port of the second amplifier, and put it in the case as shown below.
- Cut two pieces of +12V wire and tin their ends and the +12V pins of the amplifiers. Connect the two +12V pins with one wire, and attach the other to the +12V pin of the amplifier not connected to the bulkhead adapter, as shown below:



**Figure 4:** The amplifiers and filter mounted in the LNA case. The black tube on the wires is 3.4mm heat-shrink tubing, and is not necessary.

- Attach the 4” SMA cable to the “Out” port of the second amplifier and to the “RF” port of the bias-tee.
- Prepare the other SMA-F to SMA-F bulkhead connector as before and insert it through the second hole.
- Connect the “RF&DC” port of the bias-tee to the bulkhead connector.
- Tin the +12V pin of the bias-tee and solder the remaining +12V wire to this pin.
- Due to the presence of the bias-tee, the LNA has to be connected to the receiver for testing. The procedure for doing so is described after the receiver assembly instructions.



- Remove the adhesive backing from the rubber gasket provided with the case and apply it to the lid. The completed assembly is shown below. The lid can now be screwed onto the case with the provided screws. It is advised that the connectors be labeled to prevent improper connection. Some form of weatherproof label should be used.

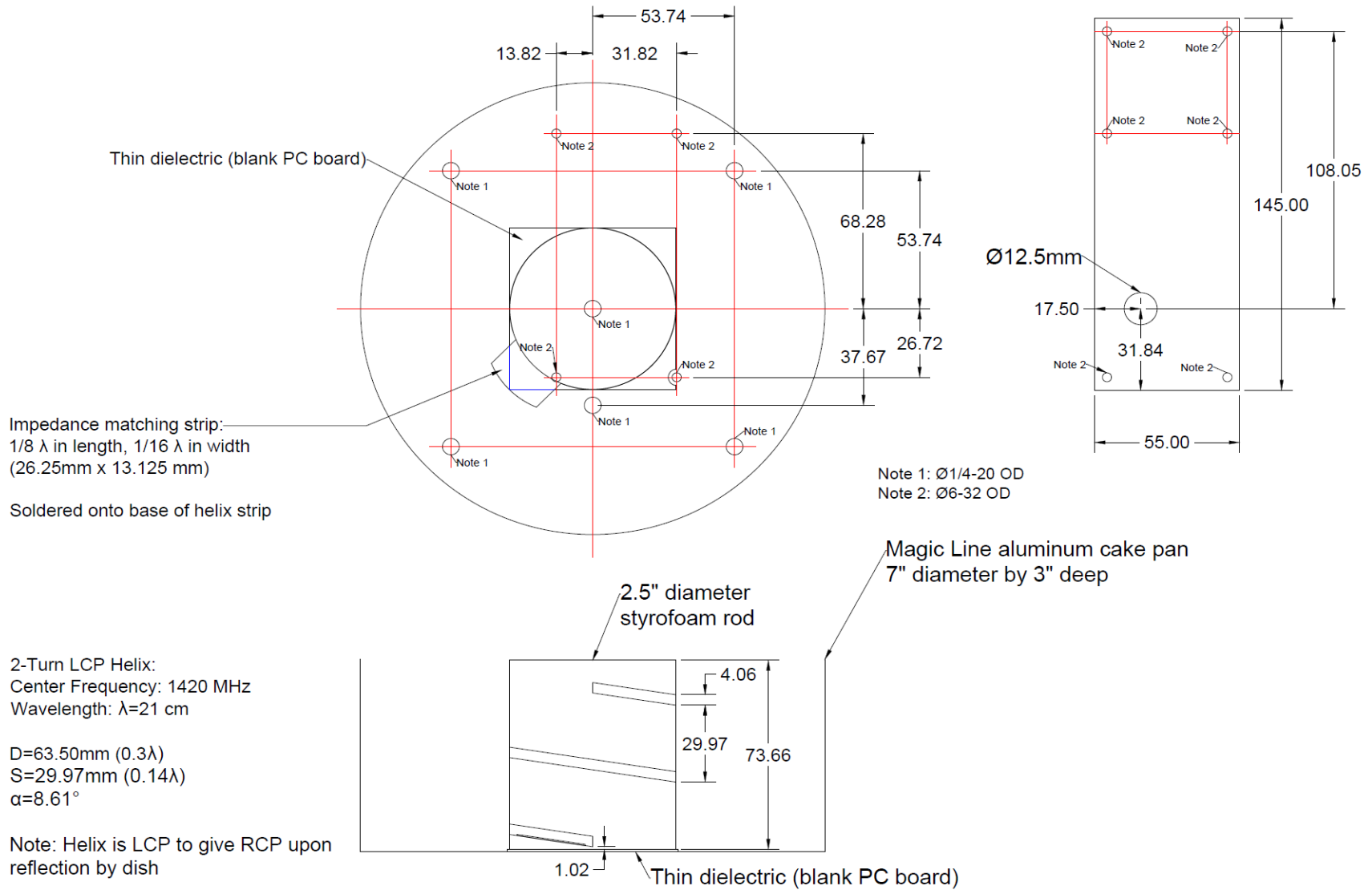


**Figure 5: Completed LNA case with gasket on the lid.**

### *Assembly of the Feed*

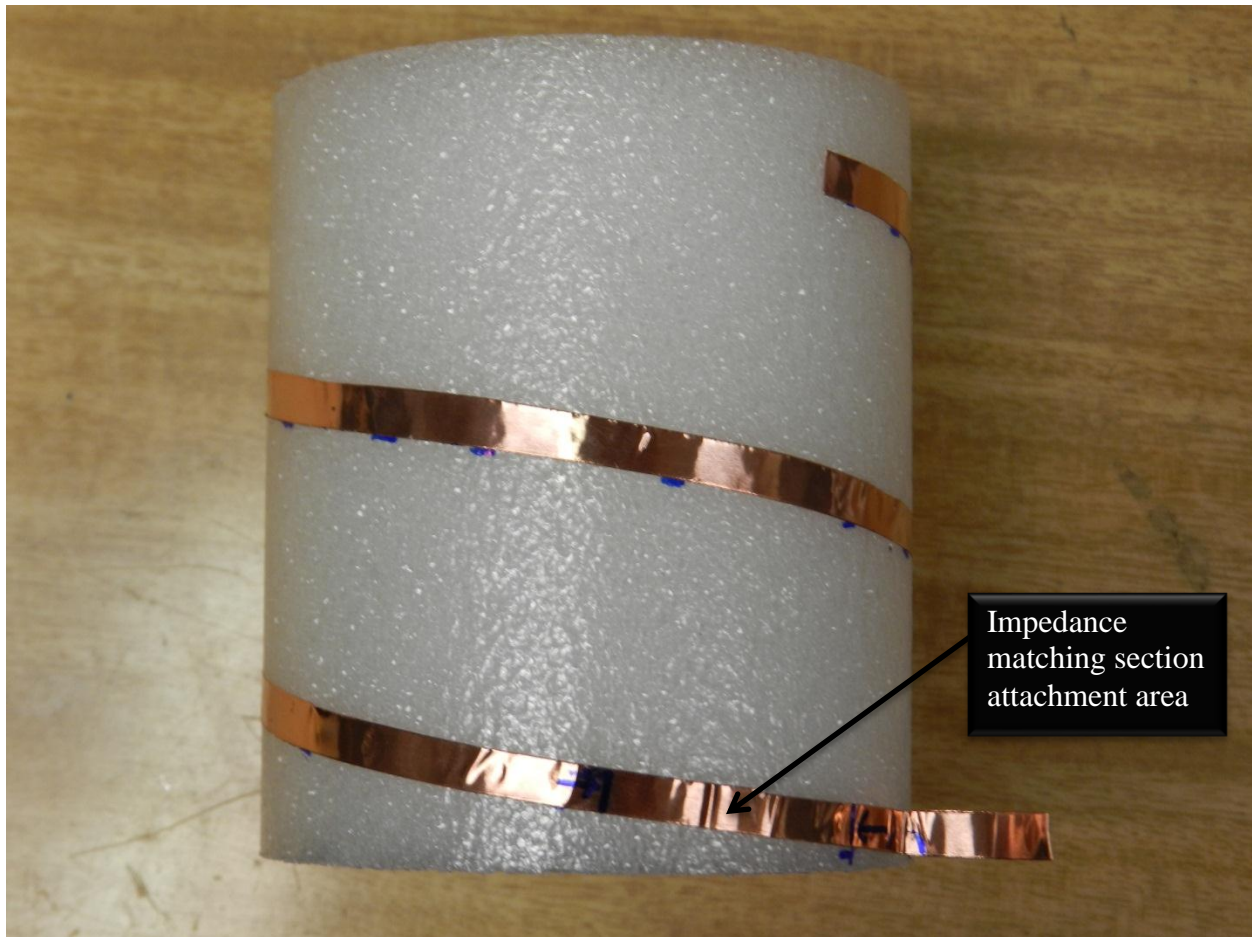
The helical antenna is the only component that has to be scratch built, and minimal machining is required for the other components. Drawing “Feed.pdf”, reproduced below, shows the feed and all dimensions. You will need the remainder of the components from the LNA and Feed section of the parts list, plus solder and tools.

- Begin by cutting a piece of the foam rod to 73.7mm in length. Drill a 6.35mm (1/4”) hole all the way along the axis of the rod.
- Select an arbitrary location on the lower edge of the rod and draw a mark 1mm from the lower edge. Make two more marks vertically above this mark, each 30mm above the mark below.



**Figure 6: Mechanical drawing of the feed and LNA mounting plate**

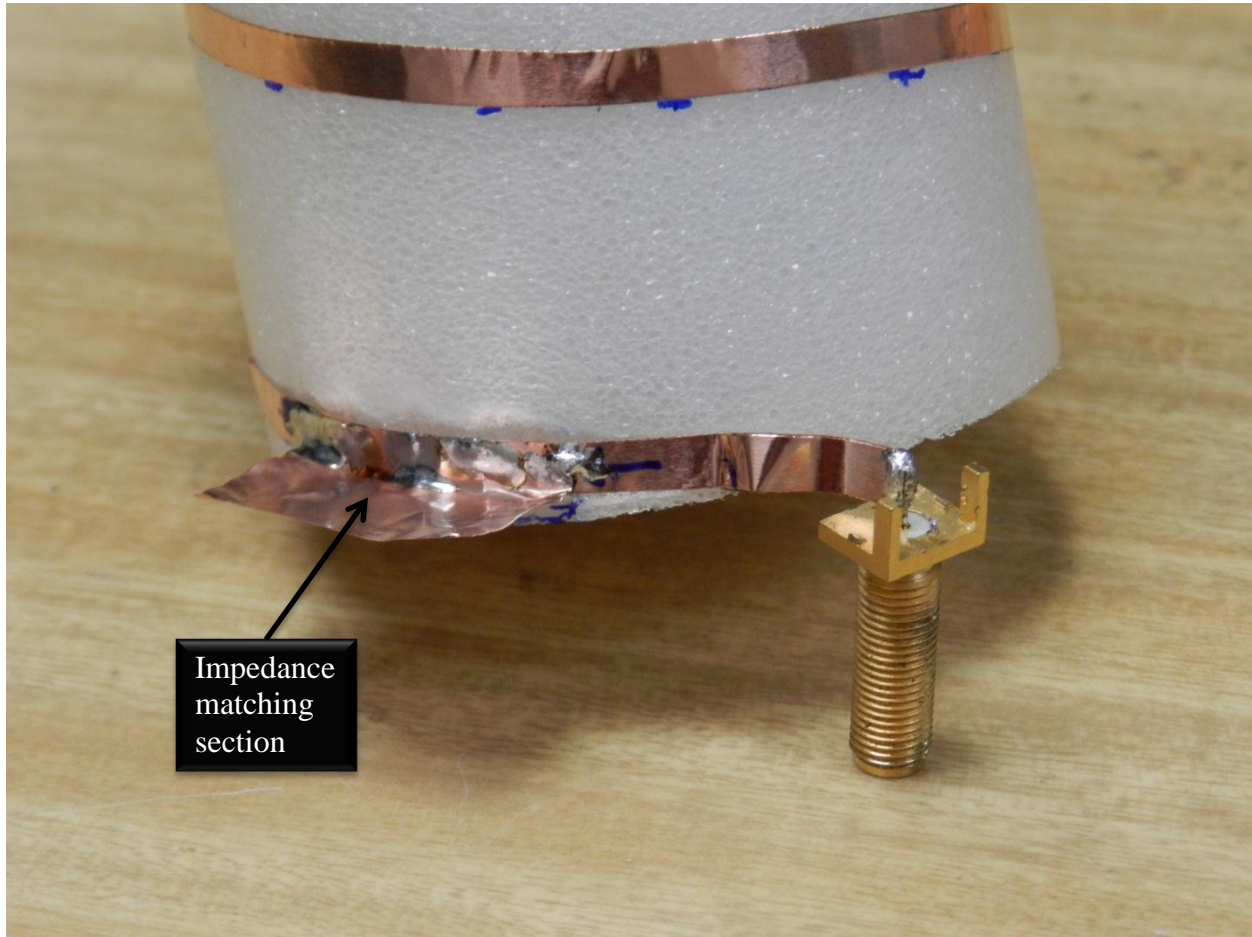
- Cut out a strip of copper tape 4mm wide and 439mm long. Tape one end at the lowest mark on the rod and wrap the strip around the foam so that the lower edge of the strip is flush with the two marks made earlier. Tape the top end of the strip to the foam. It should be 15mm past the last mark.
- With a ruler, go around the helix and make sure that the lower edge of the strip is always 30mm above the lower edge of the turn below. Once the helix is adjusted, periodically mark its position on the foam with a marker.
- Take the strip off the foam and measure in 15mm from the lower end of the strip, and bend the foil here. Make another mark 13mm from the first, and then another 26.25mm past that.
- Remove the backing from the bent portion and fold the copper over on itself. Place the bend on the lowest mark on the foam and start to remove the backing and apply the foil to the foam, keeping the helix aligned with the marks made earlier.



**Figure 7: The helix attached to the foam cylinder. Note the area for attaching the wave trap, the bent portion away from the cylinder (note that in this image it is longer than required), and the blue alignment markings on the foam.**

- Cut out a piece of foil 26.25mm by 13mm, leaving an additional 3 to 4mm wide strip on one of the long edges, to form the impedance matching section.

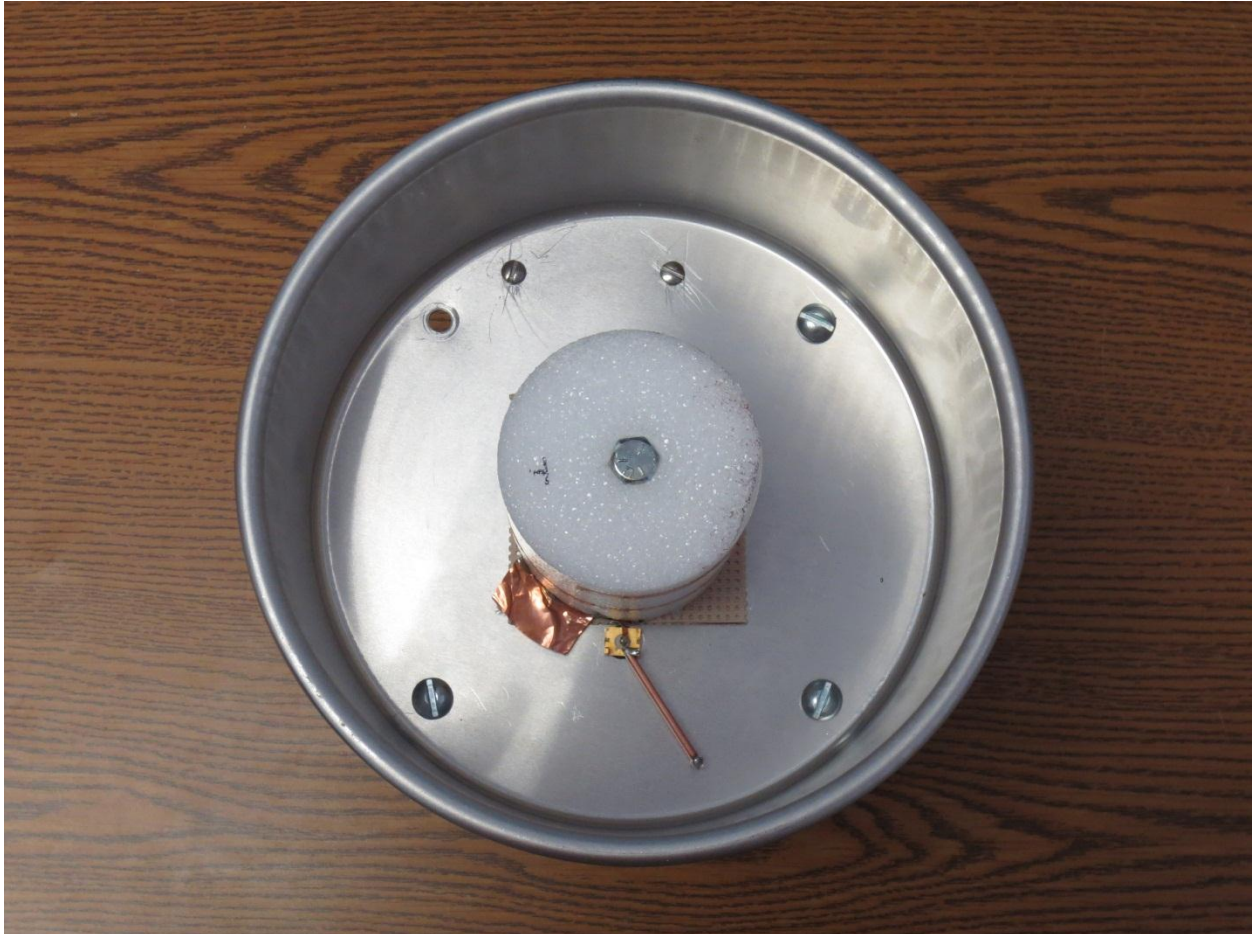
- Fold this extra strip so that it is 90° to the rest of the foil. Center it on the helix between the two marks that are 26.25mm apart and solder the extra strip to the helix. This will cause some of the foam immediately under the soldered joint to melt. This is not a problem.
- Apply a small amount of solder to the end of the bent-over portion of foil and to the pin of the SMA connector. Solder these two together so that the threaded portion of the SMA connector is pointed downwards. It may be helpful to cut off the ground pins on the connector closer to the foam rod.
- Place a ¼" O-ring on the SMA connector and push it to the end of the threads.



**Figure 8: The impedance matching section and SMA connector attached to the helix.**

- Drill the holes in the cake pan indicated on the drawing of the feed. All are referenced to the center hole, so this can easily be performed on a milling machine with digital read-out. Note that four of the holes are for mounting the feed to the dish, and these may have to be moved depending on the type of dish used.
- Insert the 1/4-20x3.25" bolt through the rod so that the head of the bolt is at the top of the rod.
- Cut out a 63mm square piece of the PC board and drill a ¼" hole in the center, and a ¼" indent and a Ø6-32 OD hole to the side as indicated in the drawing.

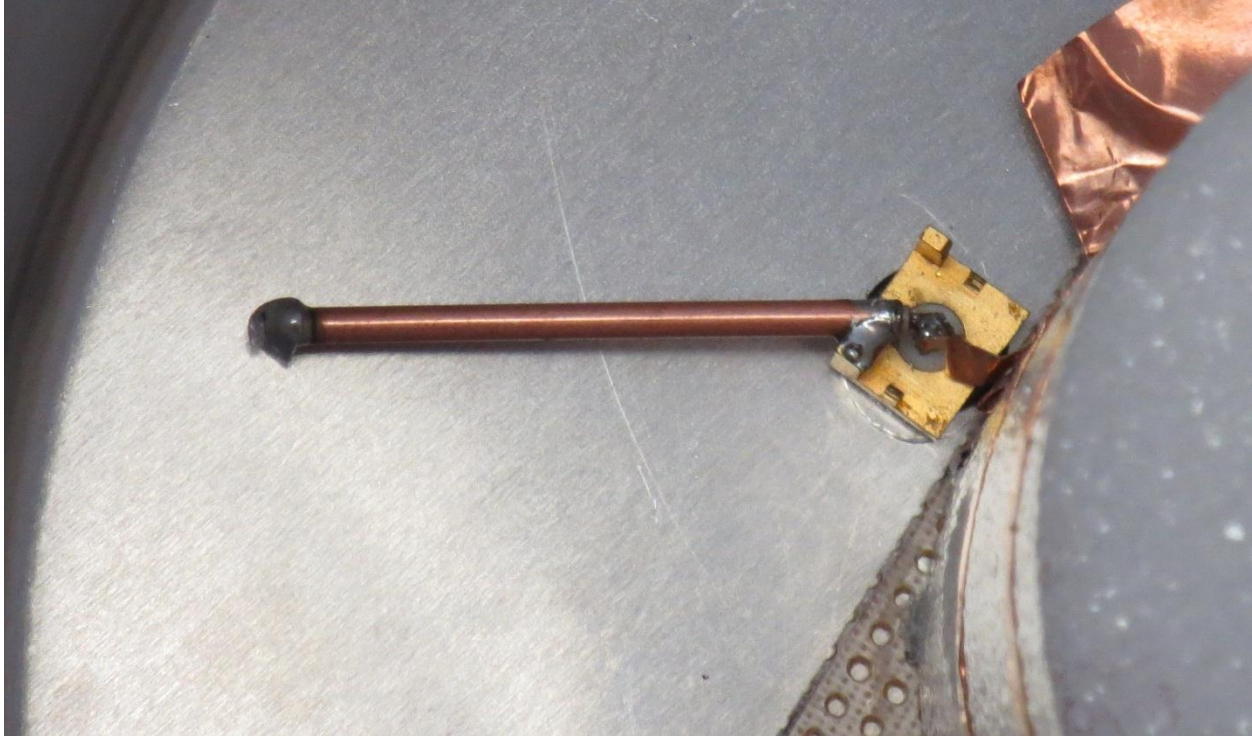
- Run the 1/4" bolt through the center hole of the board and the cake pan and a 6-32x1" machine screw through its holes in the PC board and pan. Make sure the SMA-F connector goes through its hole in the pan. Secure the 1/4-20 bolt with a nut and washer and hand tighten. Carefully secure the SMA connector with a 1/4" washer and its lock washer and nut. Make sure that the soldered end of the SMA connector is against the bottom of the cake pan and not propped up by the PC board.
- The feed's performance can now be tested with a network analyzer, if available. To do so, hook the network analyzer to the SMA connector and set it to measure S11. It should be around -20 dB.



**Figure 9: The helical antenna attached to the feed.**

- A shorted 1/4 wavelength stub should be added to the feed to act as a DC path for lightning and static protection for the amplifiers.
  - Cut out a 42mm long piece of semi-rigid coaxial cable (shorter than 1/4 wavelength due to the speed of propagation).
  - Strip the shield and insulation away from about 2mm of center conductor on one end and 4mm on the other end.
  - Bend over the 4mm end so that it touches the shield and solder it to the shield.

- On the inside of the feed, solder the center connector of the stub to the center pin of the SMA connector, and the shield of the stub to one of the ground pins on the SMA connector, as shown below:



**Figure 10: Close up of the  $\frac{1}{4}$  wavelength stub attached to the SMA connector.**

- The LNA mounting plate now has to be made. All dimensions are referenced to a single point, so this can easily be carried out on a milling machine with digital read-out. If the plate was obtained from Online Metals or a similar source, make sure that all dimensions are correct before drilling.
- Once the plate is made, secure it to the back of the pan with two 6-32x1” machine screws and nuts through the holes in the corners, and 6-32x3/8” machine screws and nuts through the holes near the center, tightening them all with a wrench.
- Put two more 6-32x1” machine screws through the holes on the far end of the plate and secure them with nuts.
- Thread a nut onto each of the 1” machine screws and place a lock washer on top of it.
- Place the LNA case onto the machine screws and connect the “To Feed” port of the LNA to the SMA connector on the feed with a SMA-M to SMA-M right angle connector.
- Raise the nuts on the four machine screws until the LNA case is parallel to the back of the pan.
- Thread another nut onto each of the four machine screws and tighten the nuts with a wrench, securing the LNA in place.



Figure 11: The completed feed and LNA assembly.

### Mounting the Feed

As noted earlier, the drawing of the feed shows four ¼” holes. These are based on the Kaul-Tronics 2.3m dish used for the prototype dish at Haystack. However, the dish you used may be different, and you will have to modify the size and placement of these holes accordingly. The feed should be mounted so that the focus of the dish is on the axis of the helix, half way along its length. To find the focus of your dish, stretch a string or wire across it to measure the diameter  $D$ . Then measure the distance  $d$  from the string to the center of the dish. The focal length  $f$ , measured from any point on the dish’s surface to the focus, can be found by:

$$f = \frac{D^2}{16d}$$

To connect the feed to the receiver, LMR-240 and LMR-400 coaxial cable was used. On the 2.3m prototype dish, a 10ft section of LMR-240 with SMA-M connectors on either end was run from the “To Receiver” connector on the LNA box along one of the quadrapod legs and round the back of the dish to the mount. It was secured to the dish every 6”-8” using UV-resistant zipties. A loose section to allow full rotation of the dish hung off the mount. A 50’ section of LMR-400 with SMA-F connectors on either end ran from the telescope inside to the

receiver location. To protect the connection between the LMR-400 and the LMR-240 at the telescope, a plastic drink bottle was cut off near the bottom and a hole large enough to allow through a SMA connector was drilling in the cap. The LMR-240 was fed through this hole and sealed in place with electrical tape. The two cables were connected together inside the bottle:



Figure 12: Weather-proof connection between the two coaxial cables.

### Assembly of the Receiver

The receiver is a combination of an image rejection mixer and a two stage amplifier. It contains a non-tunable 1416 MHz local oscillator for receiving the 21cm band. The receiver and LNA in combination should provide approximately 71 dB of gain.

The receiver was designed to make assembly as easy as possible. Most components are connected with SMA threaded cables and connectors, and minimal soldering is required. Some holes need to be drilled in the receiver case and the component mounting plate. The component mounting plate can easily be made on a milling machine with a digital read-out, and the mechanical drawing of the plate references all dimensions to a single point.

The IF 90° combiner and high pass filter are not currently available as stand-alone modules, and thus they have to be assembled from surface mount components and an enclosure. Detailed instructions on this assembly are provided below. You will need the components from the Receiver section of the parts list, plus solder and tools.



### *Receiver Mounting Plate*

The CAD drawing “ReceiverMountingPlate.pdf”, reproduced below, shows the locations and sizes of all of the holes necessary in the component mounting plate. There is a hole in each corner to mount the plate to the receiver box. All dimensions are referenced to the lower left corner of the plate. This allows the holes to be easily drilled on a milling machine with digital read-out. If such a machine is not available, a drill press, ruler, and careful measurements should suffice. If the plate was obtained from Online Metals or a similar source, make sure that all dimensions are correct before drilling.

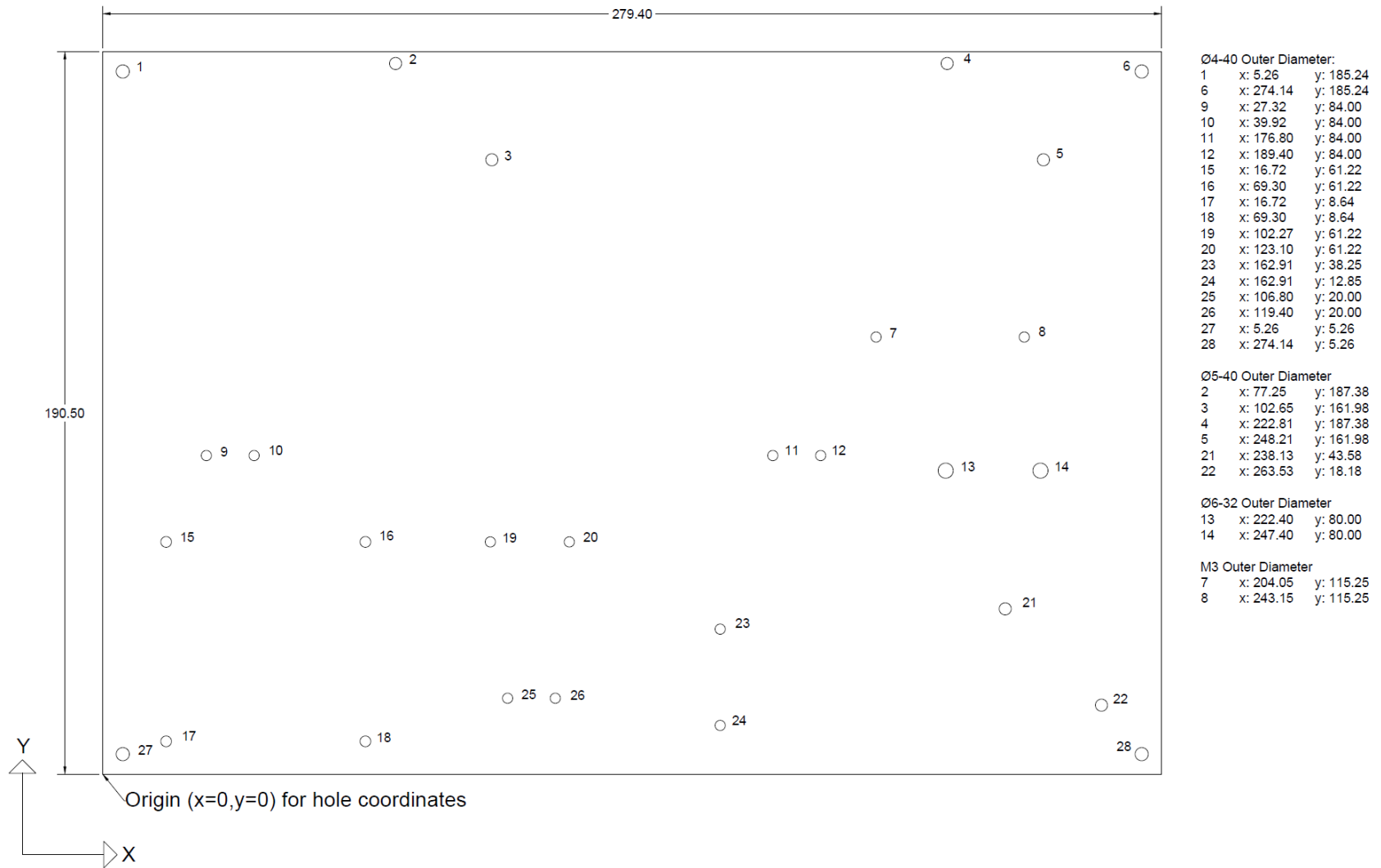
### *Receiver Box*

Seven holes need to be drilled in the receiver box: four for mounting the component plate, two for SMA connectors to the antenna and to the PCI board, and one for the power cord. A hand drill or drill press can be used. Ensure that the holes are accurately positioned. The flanges on the long edges of the box will have to have about a millimeter ground off of each one to allow the component mounting plate to easily slide in. Refer to drawing “ReceiverCase.pdf”, reproduced below, for dimensions.

### *Assembly of the 90° Combiner and High Pass Filter*

This is the only component of the receiver that requires much work to build. You will need:

- Mini-Circuits PSCQ-2-8+ power combiner
- Pomona Electronics 2392 shield box with 3 BNC female tee
- 3 Mini-Circuits SF-BM50+ SMA-F to BNC-M adapters
- TDK 0.0033  $\mu$ F ceramic capacitor
- Vector Circboard 3677-6
- Wire
- Solder
  
- The power combiner/high-pass filter module will be mounted on a piece of the Vector Circboard which is vertically installed in the box. Cut out a piece of the Circboard to fit vertically, lengthwise in the box. It will be approximately 19mm tall by 53mm long. Cut it from a part of a board so that one of the ground planes will run along the top of the board.
- Place the power combiner on the Circboard and solder it in place as shown below. Ensure that none of the pins on the power combiner are connected to a plane on the Circboard.

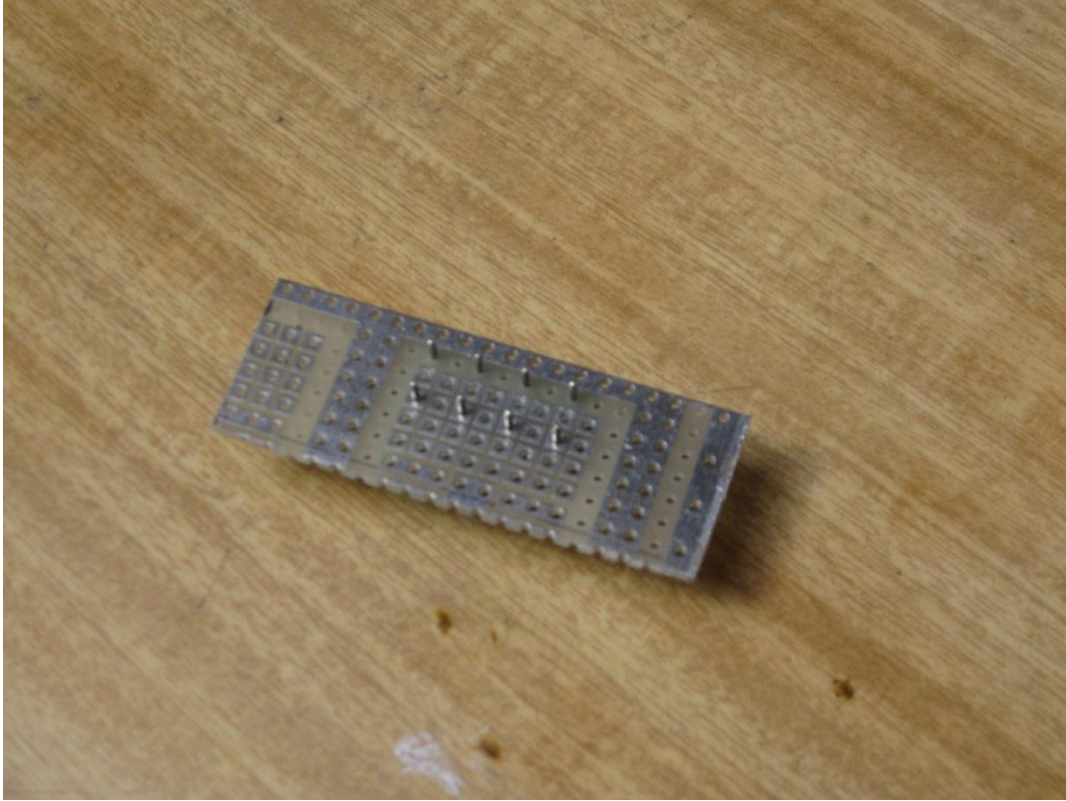


**Figure 13: Mechanical drawing of hole locations on the receiver mounting plate**

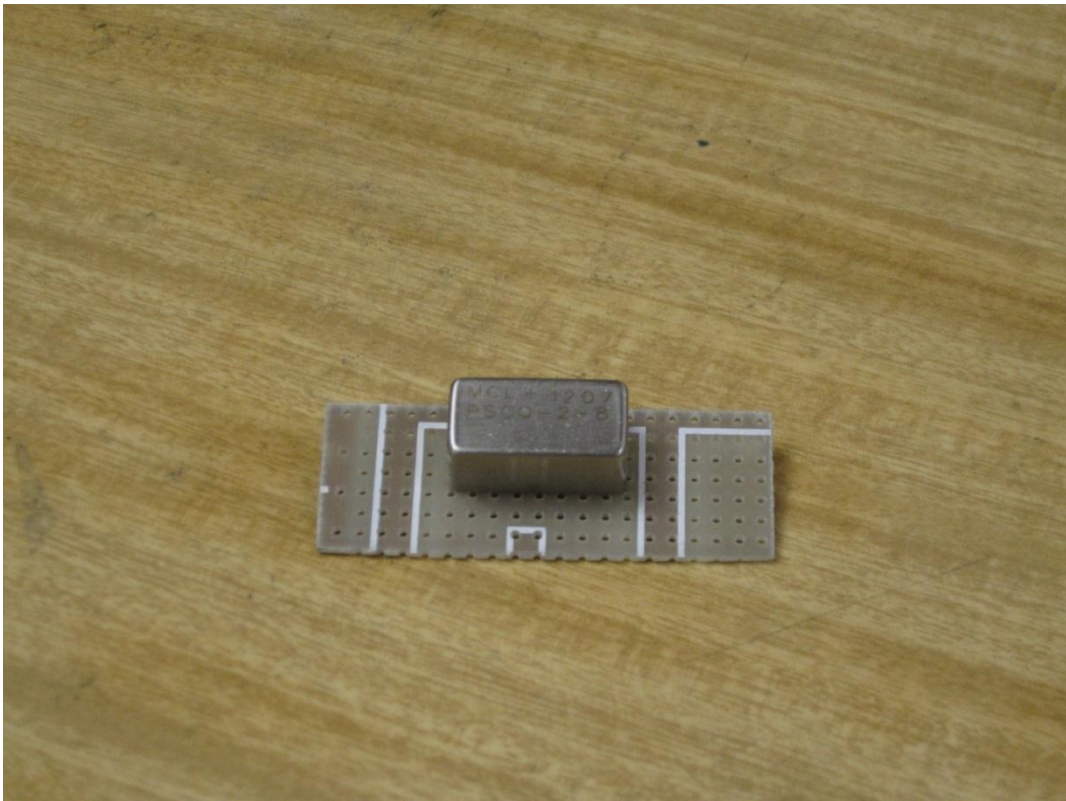


Note: all dimensions specified from outer edges of case

**Figure 14: Mechanical drawing of hole locations in the receiver case**

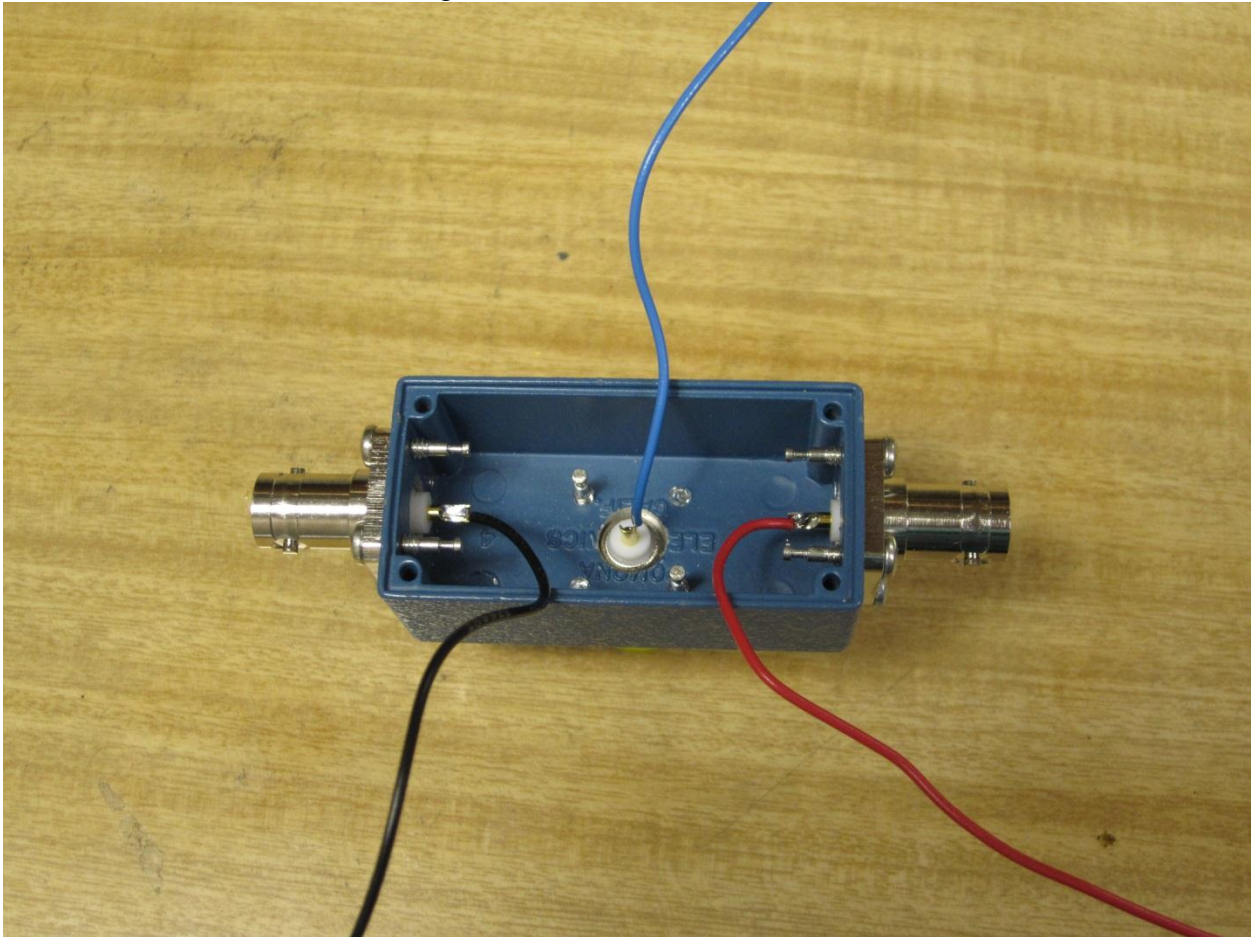


**Figure 15: The power combiner attached to the Cirboard.**



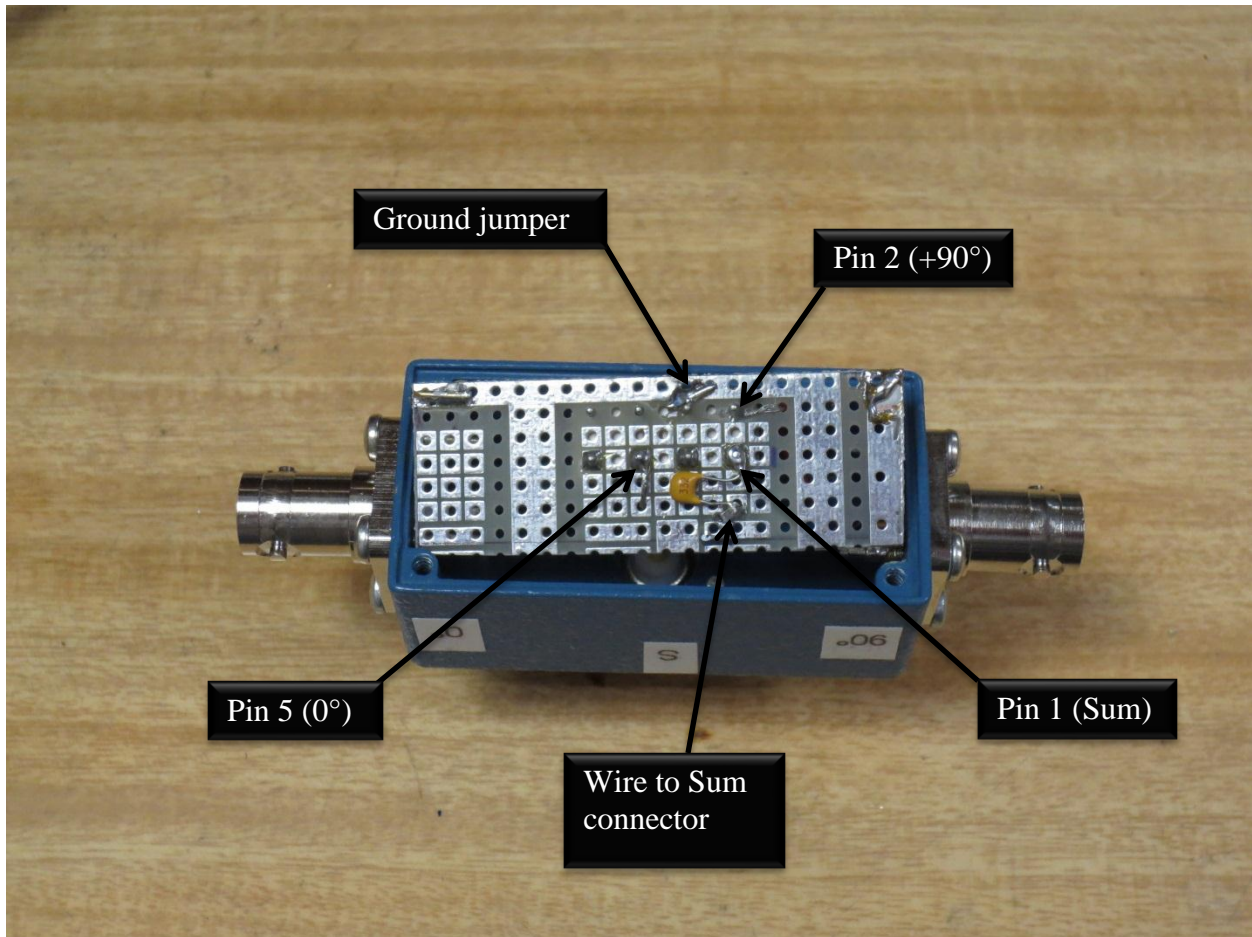
**Figure 16: Placement of the power combiner on the board. From this perspective, pin 2 is in the upper left corner.**

- Next, the wires that attach the pins of the power combiner to the connectors are soldered onto the connectors. 22 gauge stranded wire was used, soldered onto each connector and then cut down to about 4cm in length.



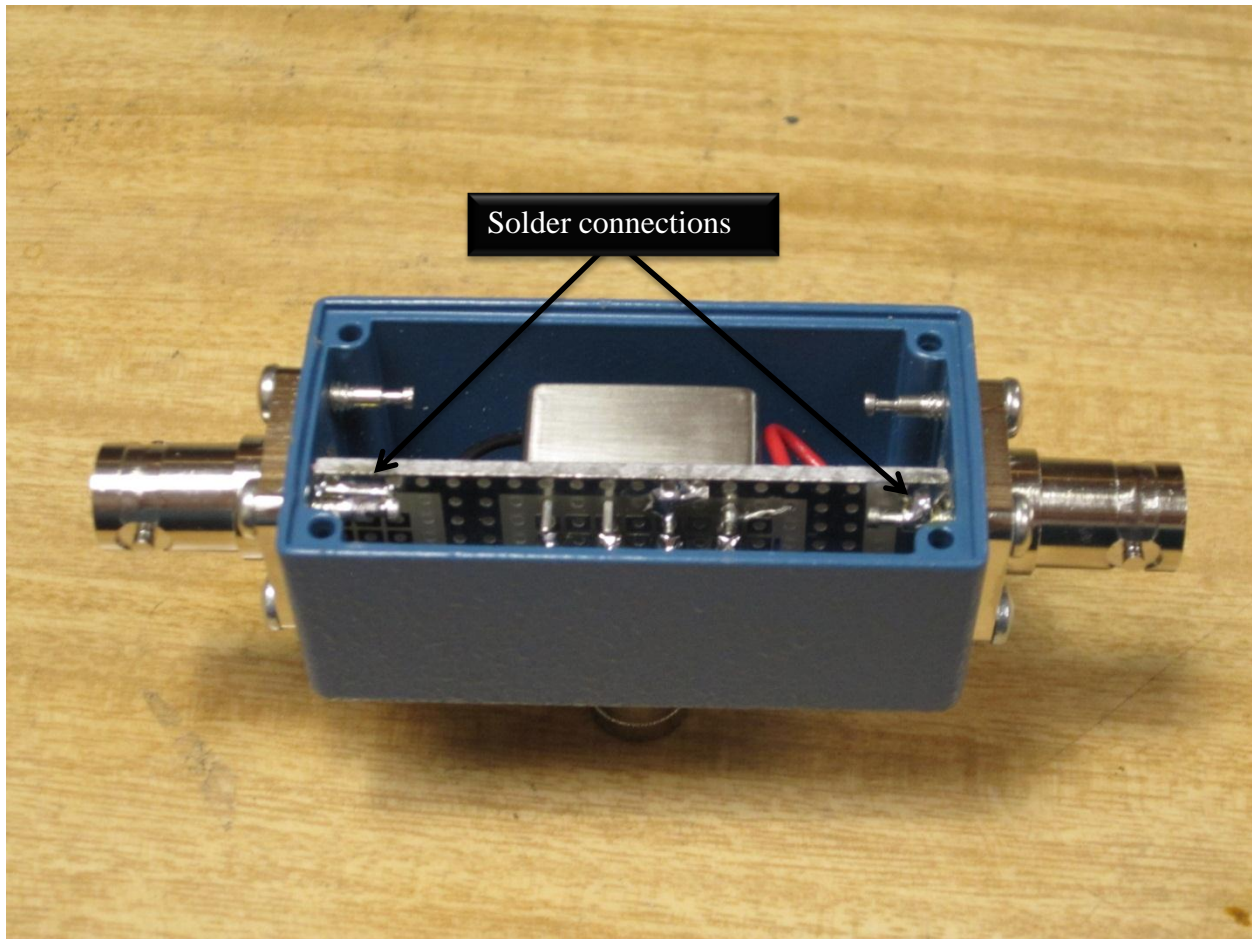
**Figure 17: Wires attached to the connectors before being cut.**

- Strip about 7mm of insulation off of the end of each wire and tin it. As of this writing pin 1 on the power combiner is the sum, pin 2 is  $+90^\circ$  and pin 5 is  $0^\circ$ . All other pins are ground except 6, which is unused. The current data sheet for the power combiner should be consulted prior to assembly.
- Push the stripped and tinned end of the wire through a hole in the circuit board adjacent to its pin. Loop the end of the wire around the pin and solder in place except for pin 1 (sum), making sure that the wire does not contact another pin or the ground plane.
- In the accompanying pictures, the blue wire attaches to the sum port (via the capacitor), red to  $+90^\circ$ , and black to  $0^\circ$ .
- A short piece of solid wire can be used to connect one of the ground pins on the power combiner to the ground plane of the board.
- Loop one lead of the capacitor about pin 1 and the other lead about the end of the blue wire and solder in place. This completed assembly is shown below:



**Figure 18: Wires and ground jumper attached to the board.**

- The final step is to fix the board into the box. The board should slip in so that the ground plane at the top of the board is pressed against the ground pins of the connectors on either end of the box, and the bottom of the board is against the insulator around the pin for the central connector.
- If the sum wire presses against one of the ground pins, remove the pin and cut off the end before putting it back in.
- Solder the ground pins on either end to the ground plane on the top of the board. A small piece of bare wire can be placed on top of the ground pin if necessary to connect the pin to the plane:



**Figure 19: The board inserted in the box.**

- Screw the provided cover onto the box and attach the SMA to BNC adapters. It is recommended that the box be labeled to indicate which connector is which.
- To test that the assembly was successful, attach a signal generator at 2-4 MHz to the sum port, and view the two outputs together on an oscilloscope. The two sine waves should be offset from each other by 90°. The signal should be cut off below about 1 MHz.

### *Final Assembly*

Now that all components are ready, the receiver can be assembled. All wires used were 22 gauge stranded wire. Note that in the pictures, brown wire is ground for all voltages, yellow is +15V, orange is +12V, and red is +5V. Heat-shrink tubing is placed over several connections, but this is not required and only helps to prevent shorts. The image below shows the completed plate with components labeled. A close-up view of the voltage regulator assembly is later provided. Also refer to the electrical schematic of the system, included below and in the file “ElectricalSchematic.pdf”.

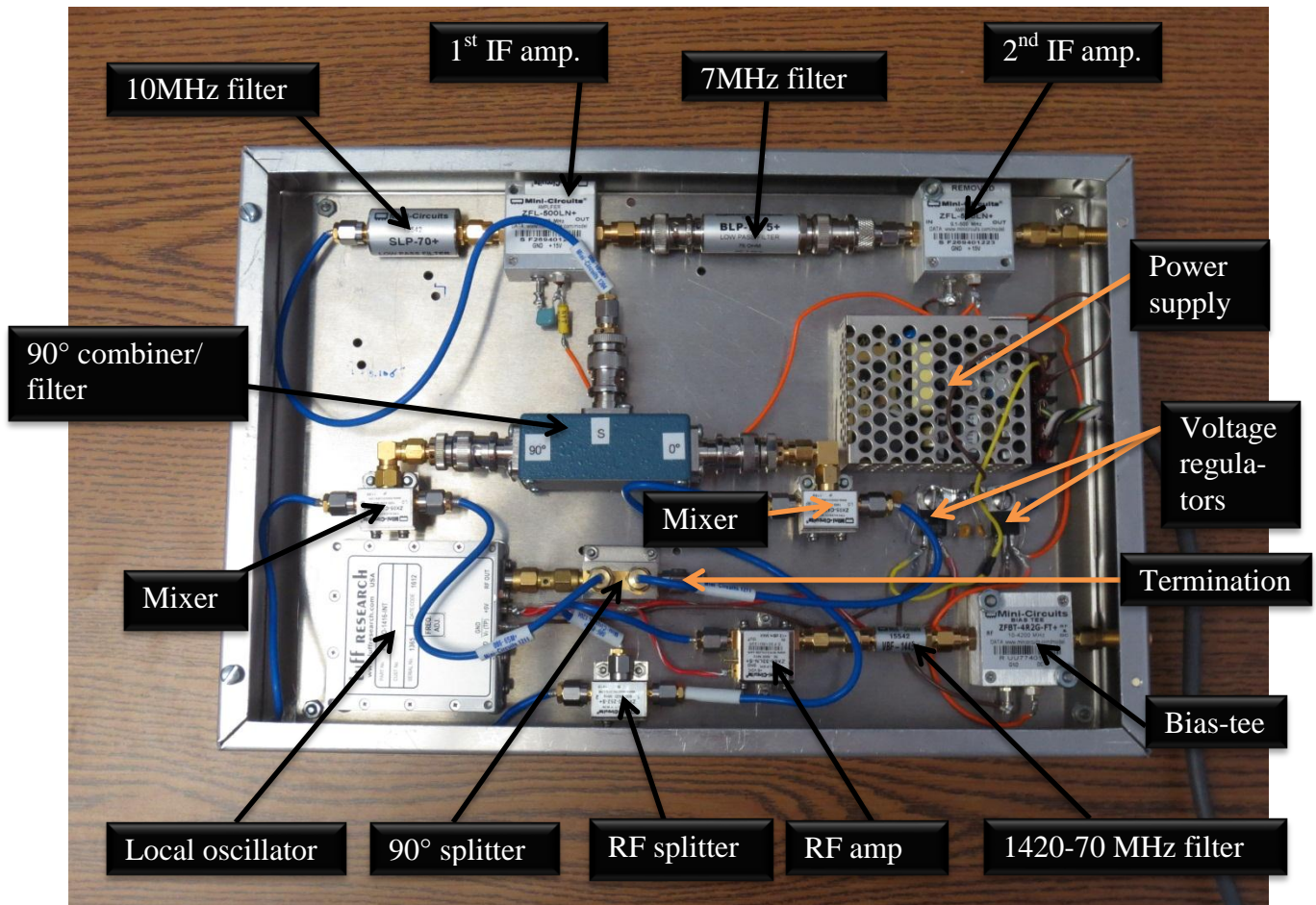


Figure 20: The completed component mounting plate in the receiver case.



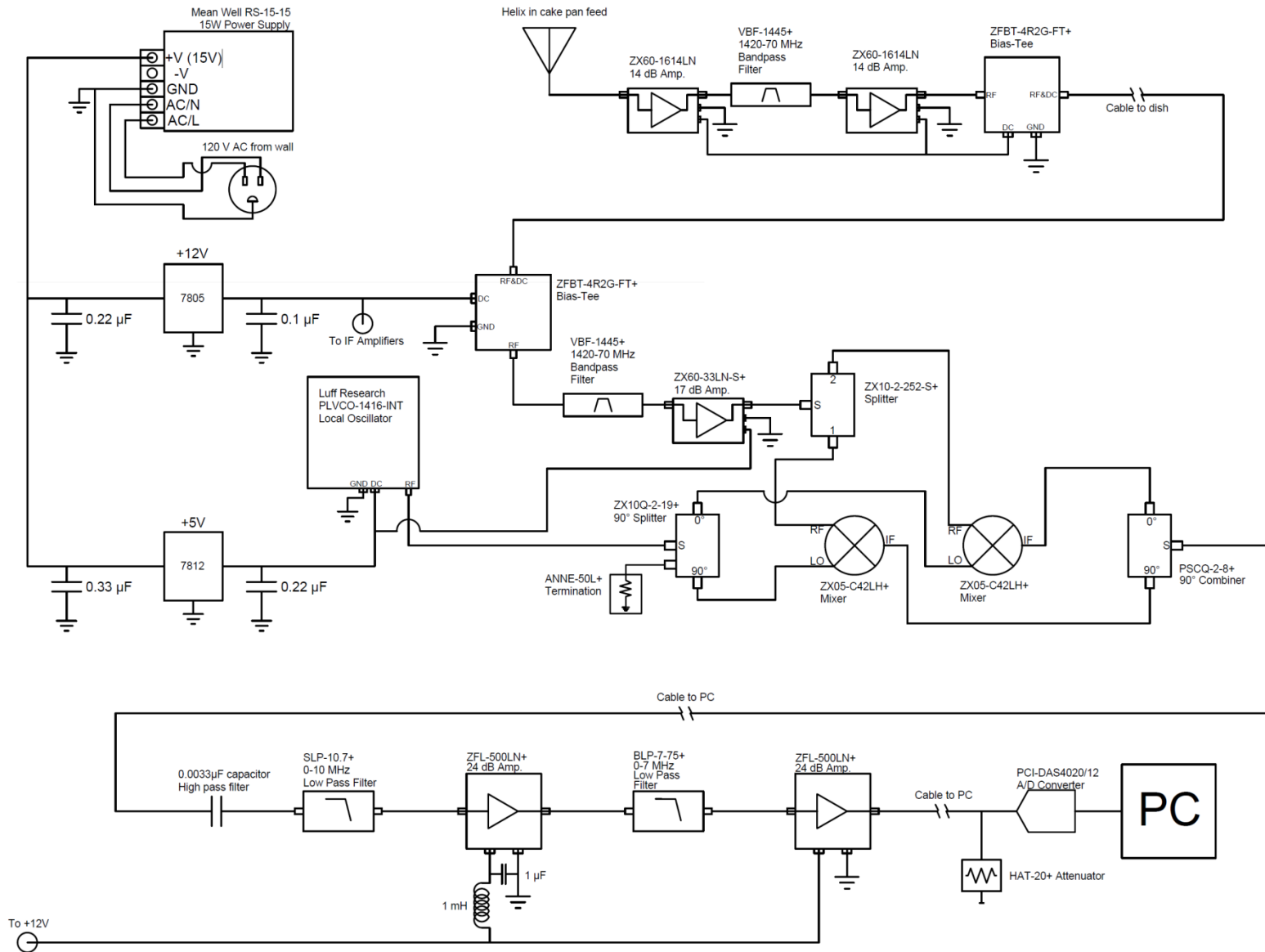


Figure 21: electrical schematic of the receiver, LNA, and computer interface.

- Take four of the 4-40x1/2" standoffs and place them in the mounting holes in the corners of the plate, securing them with nuts.
- Bolt the two voltage regulators to the component plate, with a solder lug between each regulator and the screw head, positioned so that the ends of the lugs are facing one another.
- Solder the ends of the lugs together to ensure that they are well connected.
- Attach the capacitors between the regulators and the solder lugs and solder in place, as shown in the picture below and the electrical schematic.
- Solder a short piece of +15V wire between the two inputs of the voltage regulators, sliding a piece of 3.4mm and a piece of 1.5mm heat-shrink tubing onto it first. Slide the 1.5mm tubing over the connection on the 5V regulator when finished.
- Solder a longer piece of +15V wire (about 12cm) to the input pin of the 12V regulator, and slide the 3.4mm tubing over this connection. The following picture shows a close-up of the voltage regulators after assembly is complete. Note that the 1.5mm heat-shrink tubing used is clear, and the 3.4mm tubing is black.

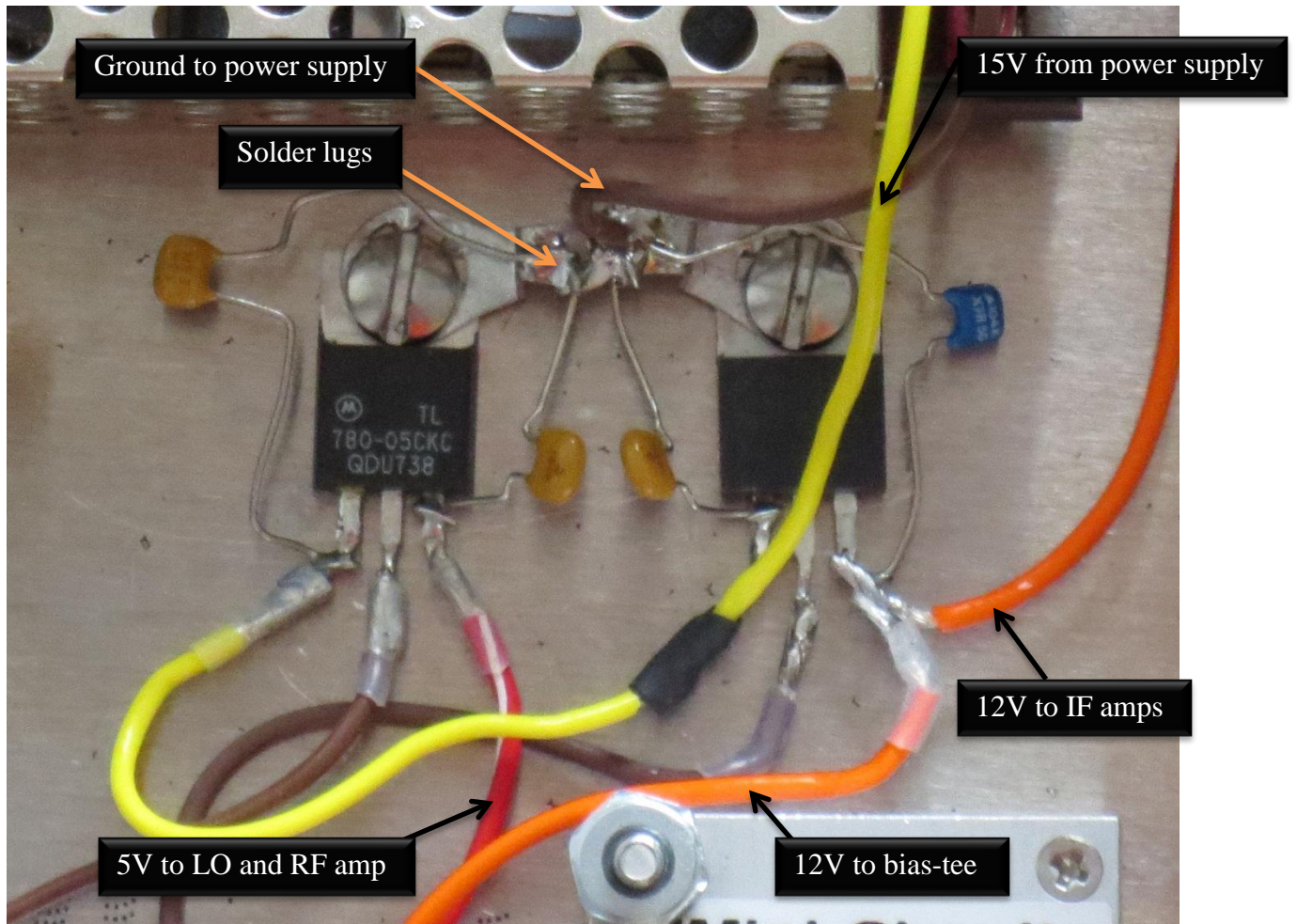


Figure 22: Close-up of the voltage regulators. The 5V is on the left and the 12V on the right.

- Screw the VBF-1445+ bandpass filter directly to the “RF” port of the bias-tee.
- Attach an SMA-M to SMA-M adapter to the other end of the filter, and attach the “In” port of the ZX60-33LN-S+ amplifier to the other end of the adapter. Lightly tighten all these connections with a wrench.
- Bolt the bias-tee to the board, “RF&DC” port towards the near narrow edge of the plate, with two 5-40x1” screws, placing a washer between the nut and the top of the bias-tee.
- Bolt the amplifier to the board with two 2-56x1/2” screws, placing two nuts between the plate and the amplifier on each screw, so that the amplifier is level.
- Bolt the ZX10-2-252-S+ RF splitter to the board, the connector on the side facing the close long edge of the plate. Use two 2-56x1/4” machine screws and nuts.
- Attach the “Sum” port of the ZX10Q-2-19 90° splitter to the RF output of the Luff Research oscillator with one of the SMA-M to SMA-M adapters, tightening the connections lightly with a wrench.
- Bolt the Luff Research oscillator to the board with four 4-40x3/4” screws, running them through a washer and then a nut between the plate and the oscillator. This should allow the oscillator and 90° splitter to both be level.
- Bolt the splitter to the plate with two 2-56x3/8” screws and nuts.
- Attach the ANNE-50L+ termination to the 90° splitter on the end opposite the oscillator. Tighten it lightly with a wrench.
- Attach the “IF” ports of the two mixers to the 90° and 0° ports of the combiner module built earlier, using the two SMA-M to SMA-M right-angle adapters and two SMA-F to BNC-M adapters, lightly tightening the connections with a wrench.
- Attach the other four 4-40x1/2” standoffs to the mixers with nuts.
- Bolt the standoffs to the plate with 4-40x1/4” screws.
- Attach a third SMA-F to BNC-M adapter to the sum port of the combiner module.
- Attach the SLP-10.7+ low pass filter to the “In” port of one of the ZFL-500-LN+ amplifiers.
- Attach one of the SMA-M to BNC-M adapters to one end of the BLP-7-75+ low pass filter, and the BNC-F to SMA-M adapter to the other end.
- Connect the other end of the BLP-7-75+ low pass filter to the “In” port of the second IF amplifier. Note that the BLP-7-75+ filter may become available with SMA connectors in the future, and it is recommended that BNC version be replaced should this happen.
- Bolt this entire assembly to the plate with four 5-40x1” screws, two through each amplifier, with a washer between the nut and the top of each amplifier.
- Bolt the power supply to the board with two M3x6 screws, with the screw terminal near the closer short edge of the board.
- Strip the insulation from the end of the long +15V wire soldered to the 12V voltage regulator and crimp it into a ring terminal. Attach this to the +V terminal of the power supply.
- Solder a ground wire onto the ground lugs of the voltage regulators. Strip the insulation from the other end and crimp a ring terminal onto it. Attach this ring to the –V terminal of the power supply.
- Strip off a short section of the outer insulation from the power cable and separate the three wires. Strip off about 7mm of insulation from each wire and twist the strands together. Crimp a ring terminal on each wire. Attach each wire to the terminal on the

power supply. Be sure that the wires go to the correct terminals before powering the supply: black to L, white to N, and green to ground.

- Before wiring in the amplifiers, bias-tee, and oscillator, check the connections on the voltage regulators and make sure that there are no shorts. Plug in the power supply and make sure that each regulator is supplying the correct voltage. Once this test is complete, the wires can be soldered on.
- Solder a piece of ground wire between the ground pin of the bias tee and the ground pin of the 12V regulator, sliding a piece of 1.5mm heat-shrink tubing over this connection.
- Connect the +12V pin of the bias-tee to the output pin of the 12V regulator.
- Solder another +12V wire onto the output pin of the 12V regulator, making sure it is long enough to reach the second IF amplifier.
- Strip the insulation from the ends of another piece of +12V wire, making sure that it is long enough to connect the +15V pins of the two IF amplifiers. Note that both IF amplifiers are being powered by 12V rather than 15V.
- Twist together one end of the wire from the 12V regulator to the second IF amplifier and one end of the wire that will connect the IF amplifiers. Tin the connection and solder it onto the +15V pin of the second IF amplifier.
- Cut a piece of +5V wire long enough to reach from the output pin of the 5V regulator to the 5V pin of the local oscillator and strip insulation off of each end.
- Cut another piece of +5V wire long enough to connect the 5V pins of the local oscillator and ZX60-33LN-S+ amplifier and strip insulation off the ends.
- Twist together and tin one end of each wire, and tin the other ends of the wires.
- Solder the twisted connection to the 5V pin of the local oscillator, and the other ends to the output of the 5V regulator and the 5V pin of the amplifier.
- Shorten the leads on the 1  $\mu$ F capacitor, wrap them around the 15V and ground pins of the first IF amplifier, and solder in place.
- Shorten the leads of the 1 mH inductor and tin them. Solder one lead to the 15V pin of the first IF amplifier. Connect the loose end of the +12V wire from the second IF amplifier to the other end of the inductor. This is shown below:

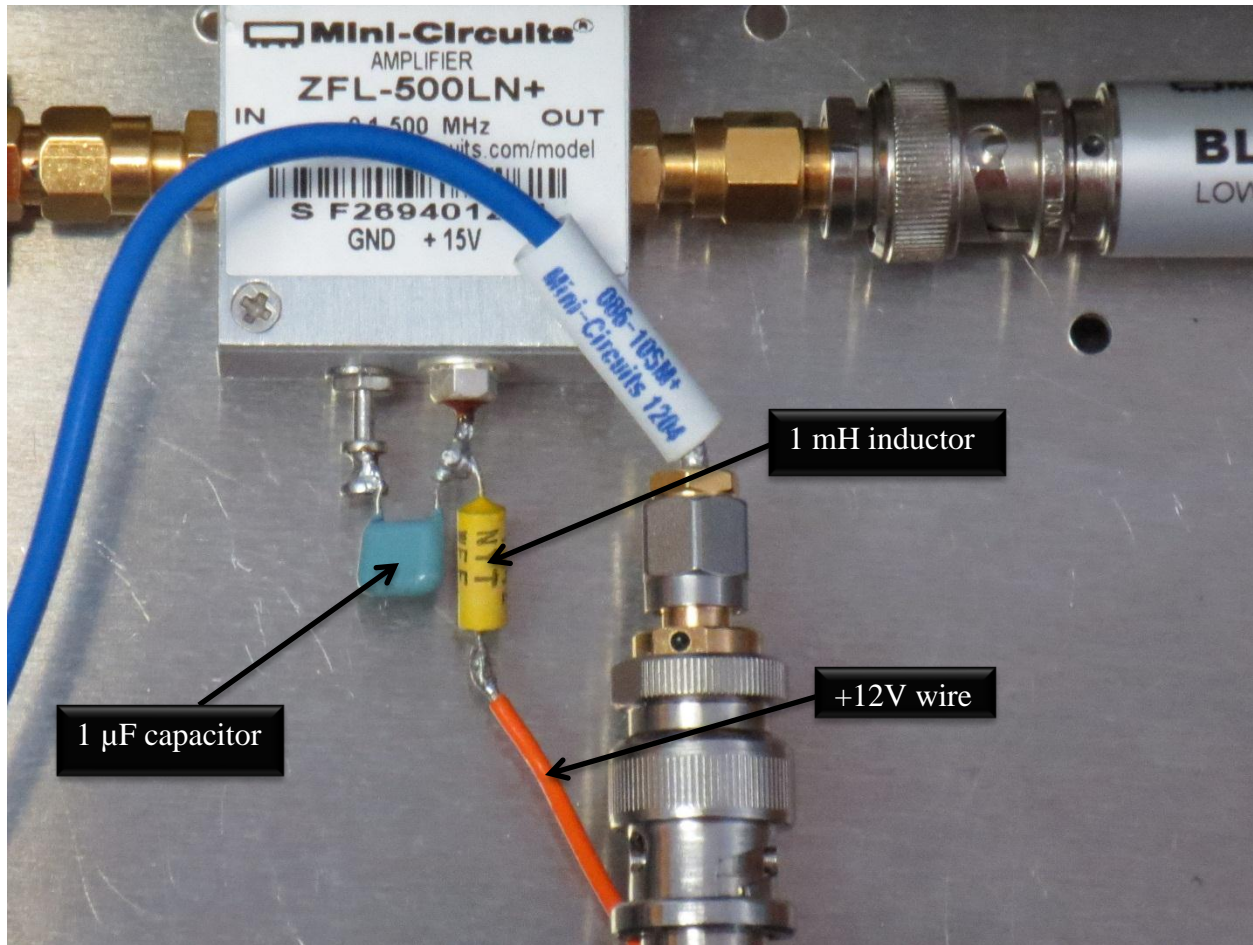


Figure 23: Filtering on the power to the first IF amplifier.

- Using a heat gun, carefully shrink the heat-shrink tubing on the voltage regulator connections. Take care to not let any of the surrounding components get too hot.
- The SMA cables between the components can now be attached. Lightly tighten each connection with a wrench. The following table shows which lengths to use:

Connection	Cable length
RF amplifier to RF splitter	4"
RF splitter to RF ports of mixers	10"
90° splitter to LO ports of mixers	6"
90° combiner to filter	10"

Table 1: SMA cable lengths for the receiver

The receiver should now be tested to ensure it is working properly. Connect the LNA to the receiver with a short SMA cable. Connect the input of the LNA to a signal generator and set it to 1420 MHz with a power of around -80 dBm. Connect the output of the receiver to a spectrum analyzer, which should be set to display around 2 MHz to 6 MHz at a reference of 0 dBm or thereabouts. Turn on the signal generator. There should be a clear signal at 4 MHz on the

spectrum analyzer, at about 71 dB higher than the input from the signal generator. The frequency of the signal generator can be varied to check image rejection at an input of 1412 MHz.

Once testing is complete, the receiver can be completed.

- Detach the power cable from the power supply. Run the power cable through its hole in the receiver case and under the mounting plate, and reattach it to the power supply terminal.
- Place the component mounting plate in the case and attach it to the case with four 4-40x3/8" screws, one into each standoff on the bottom of the plate.
- Take the four adhesive rubber feet and apply them to the bottom of the case, near the corners, to prevent the screw heads from damaging whatever surface the receiver is placed on.
- Remove the nut and lock washer from two SMA-F to SMA-F bulkhead adapters, and run the longer side into the case from the outside. They should line up with the "RF&DC" port of the bias-tee and the SMA-M to SMA-M adapter on the second IF amplifier.
- Connect the bulkhead adapters to these ports, lightly tightening them with a wrench. The flange on the bulkhead adapters should be flush with the case.
- Place the cover on top of the case and attach it with four 1/4" #6 sheet metal screws.
- It is recommended that the SMA connectors on the outside of the case be labeled, and a warning put on the connector to the bias-tee as it also carries 12 VDC:

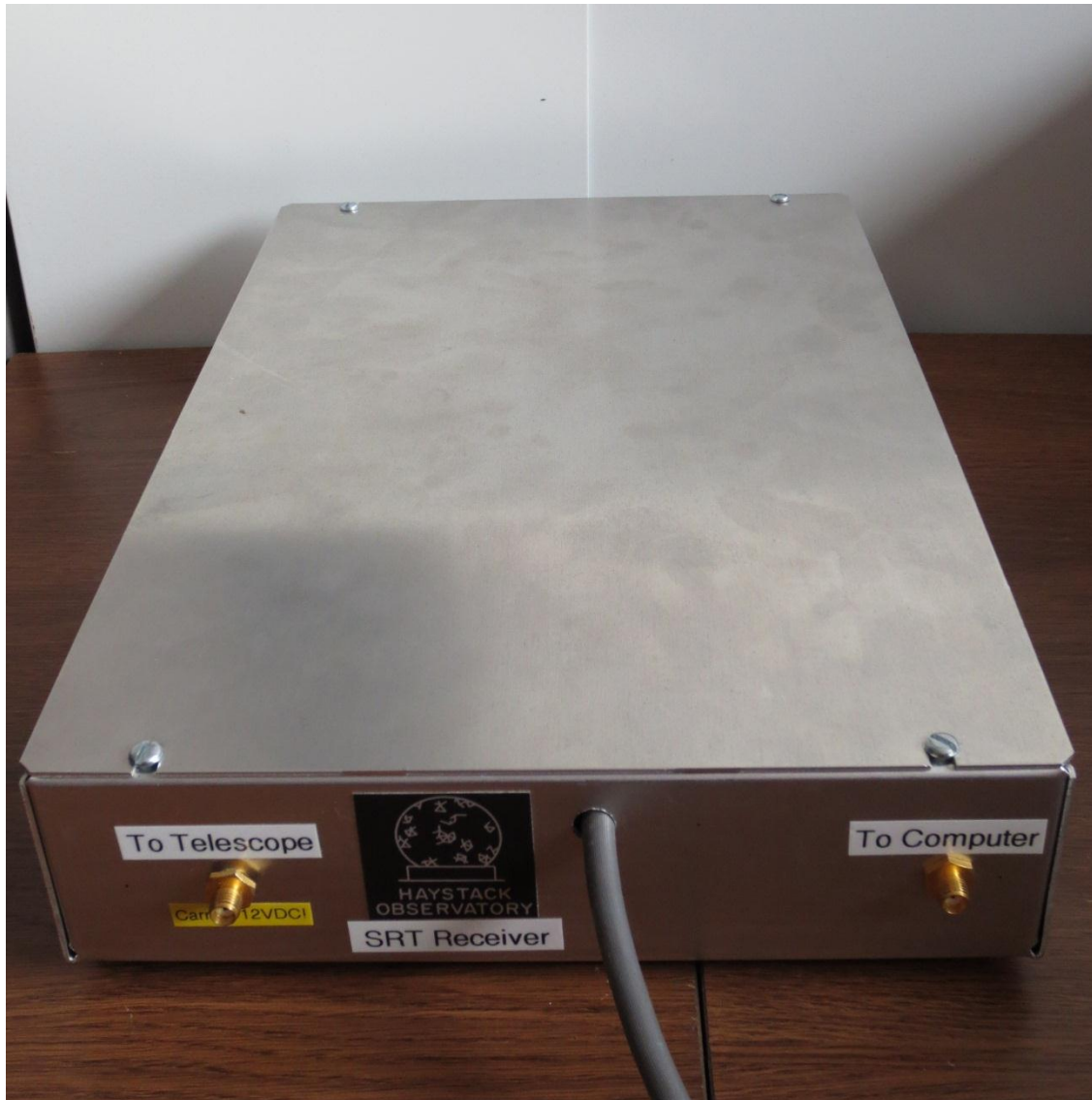


Figure 24: The finished receiver. Note that on the final design the power cord emerges from the back.

### PC Interface

You will need the components from the PC Interface section of the parts list. Data from the receiver is collected by an A/D converter on a PCI card that occupies one of the card slots in a normal desktop computer. Install it following normal procedures for installing cards in PCs. To match the receiver to the ADC, connect the BNC tee to the first port of the card. Connect the SMA to BNC cable from the receiver onto one junction of the tee, and the 50 $\Omega$  termination onto the other junction.

### Rotor Controller

There are several possibilities for the controller that interfaces between the computer program and the rotor. The SPID rotor is available with two different control boxes/power supplies, both of which are made by SPID: the Rot2Prog and the MD-01/PS-01. They are

available in many countries from different resellers (see the SPID website<sup>9</sup> for a list). Alfa Radio<sup>10</sup> is the North American distributor, though they only carry the Rot2Prog at present. The provided SRT software is (will be soon) compatible with both of the SPID controllers. The SRT software is designed to work with both azimuth and elevation limit switches. The SPID rotor comes equipped with only an elevation limit switch, and programmable electronic limits are built into the controller. The SRT software should work without the azimuth limit switch, but as of this writing this has not yet been tested.

The schematics and code for the original Stamp microprocessor-based controller from CASSI are available on the Haystack website. The SRT control program was originally designed for this system and it is still supported but must be built by the user.

### *Rotor Alignment*

To accurately track objects, the computer must know where the telescope is pointing. For the Rot2Prog and MD-01 controllers, the telescope's position relative to north is electronically set. For the original CASSI system, azimuth limit switches must be installed and the rotor physically oriented towards north.

For both controllers made by SPID, the telescope must be pointed due north and the controller reset.

- First, open srt.cat in a text editor and change the azimuth limits line from:

```
AZLIMITS 28 355
```

To:

```
AZLIMITS 0 355
```

And the elevation limits line from:

```
ELLIMITS 7.0 89.0
```

To:

```
ELLIMITS 0.0 89.0
```

- Start the SRT software and command the telescope to zero azimuth and elevation using the azel button.
- Once the telescope is pointed, carefully turn the mount until the dish is facing towards true north. The direction of true north can be found using a compass and knowing your location's magnetic declination. This can be found for anywhere in the world from the calculator<sup>11</sup> on NOAA's website.
- If you are using the Rot2Prog controller: turn the controller off. Hold down the "F" button on the front of controller and while doing so, turn it back on. The controller should show 0.0 in both the azimuth and elevation readouts, and the mode readout should be blank.

---

<sup>9</sup> [www.spid.alpha.pl/english/08.php](http://www.spid.alpha.pl/english/08.php)

<sup>10</sup> [www.alfaradio.ca](http://www.alfaradio.ca)

<sup>11</sup> [www.ngdc.noaa.gov/geomag-web/#declination](http://www.ngdc.noaa.gov/geomag-web/#declination)



- If you are using the MD-01 controller: this controller is designed for use with a variety of different rotors, and several settings must be configured. Press “S” on the controller to enter configuration. The left and right arrow keys cycle through the settings. The up and down arrow keys cycle through the options for each setting. Pressing “S” with an option highlighted selects that option. The following settings need to be configured:
  - TEMPLATE: set to 1:AZ, 2:EL
  - CONTROL AE: set to COM 0. If this setting is not available, the TEMPLATE setting above was incorrectly set.
  - PROT.: set to SPID ROT
  - TYPE: set to DIGITAL
  - INPUT: set to ELECTRONIC
  - BAUD: set to 2400
  - DATA BITS: set to 8
  - STOP BITS: set to 1
  - PARITY: set to none
- Press “F” and then the left arrow key on the controller to exit configuration mode and save the changes made. Press “F1” and the left arrow key to set current azimuth position to zero. Press “F1” and the up arrow key to set current elevation position to zero.

For further information on these two controllers, see their manuals. They can be found on Alfa Radio’s website at:

[http://alfaradio.ca/downloads/Spid\\_CD\\_10may2012/](http://alfaradio.ca/downloads/Spid_CD_10may2012/)

The manuals are in their respective labeled folders.

### **A Note on Calibration**

The SRT control software has a calibration feature which is made more accurate by having the telescope pointing at an absorber. There are three possibilities for such an absorber: hold one in front of the feed by hand; attach an absorber to an actuator which can move it in front of the feed; and have a position on the horizon where the telescope can point mostly/entire into a tree or bush.

The absorber directly in front of the feed has the benefit of blocking out most RFI and HI emission from the calibration. It has the disadvantage of reflecting some noise from the LNA, which will not be an issue with the tree.

The actuated absorber is not currently supported in the software or hardware, but it appeared in previous versions of the SRT and so documentation is available. Care must be taken to preserve the absorber foam from the elements and wildlife that may seek to use it for nest material.